

Features

- Epitaxial Planar Die Construction
- Surface Mount Package Suited for Automated Assembly
- Simplifies Circuit Design and Reduces Board Space
- **Lead Free/RoHS Compliant (Note 1)**
- **"Green" Device (Note 2)**

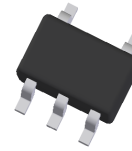

Mechanical Data

- Case: SOT-353
- Case Material: Molded Plastic. UL Flammability Classification Rating 94V-0
- Moisture Sensitivity: Level 1 per J-STD-020C
- Terminal Connections: See Diagram
- Terminals: Finish – Matte Tin Annealed Over Alloy 42 Leadframe. Solderable per MIL-STD-202, Method 208
- Marking Information: See Page 2
- Ordering Information: See Page 2
- Weight: 0.006 grams (approximate)

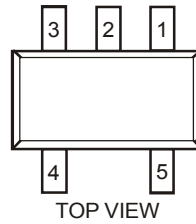

SOT-353

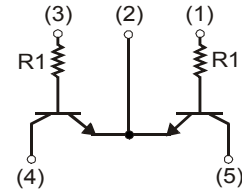

Schematic and Pin Configuration

Maximum Ratings @T_A = 25°C unless otherwise specified

Characteristic	Symbol	Value	Unit
Collector-Base Voltage	V _{CB0}	50	V
Collector-Emitter Voltage	V _{CEO}	50	V
Emitter-Base Voltage	V _{EBO}	5	V
Collector Current	I _C	100	mA

Thermal Characteristics

Characteristic	Symbol	Value	Unit
Power Dissipation @T _A = 25°C (Note 3)	P _D	150	mW
Thermal Resistance, Junction to Ambient Air @T _A = 25°C (Note 3)	R _{θJA}	833	°C/W
Operating and Storage Temperature Range	T _J , T _{STG}	-55 to +150	°C

Electrical Characteristics @T_A = 25°C unless otherwise specified

Characteristic	Symbol	Min	Typ	Max	Unit	Test Condition
Collector-Base Breakdown Voltage	V _{(BR)CBO}	50	—	—	V	I _C = 50μA, I _E = 0
Collector-Emitter Breakdown Voltage	V _{(BR)CEO}	50	—	—	V	I _C = 1mA, I _B = 0
Emitter-Base Breakdown Voltage	V _{(BR)EBO}	5.0	—	—	V	I _E = 50μA, I _C = 0
Collector Cut-Off Current	I _{CBO}	—	—	0.5	μA	V _{CB} = 50V, I _E = 0
Emitter Cut-Off Current	I _{EBO}	—	—	0.5	μA	V _{EB} = 4V, I _C = 0
Collector-Emitter Saturation Voltage	V _{CE(SAT)}	—	—	0.3	V	I _C = 10mA, I _B = 1mA
DC Current Gain	h _{FE}	100	330	600	—	V _{CE} = 5V, I _C = 1mA
Gain-Bandwidth Product (Note 4)	f _T	—	250	—	MHz	V _{CE} = 10V, I _E = -5mA, f = 100MHz
Input Resistance	R ₁	7	10	13	kΩ	—

- Notes:
1. No purposefully added lead.
 2. Diodes Inc.'s "Green" policy can be found on our website at http://www.diodes.com/products/lead_free/index.php.
 3. Device mounted on FR-4 PCB; pad layout as shown on Diodes Inc. suggested pad layout document AP02001, which can be found on our website at <http://www.diodes.com/datasheets/ap02001.pdf>.
 4. Characteristics of transistor. For reference only.

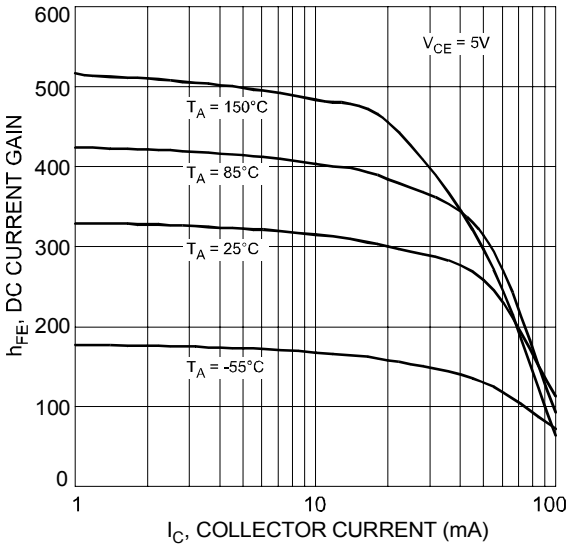

Fig. 1 Typical DC Current Gain vs. Collector Current

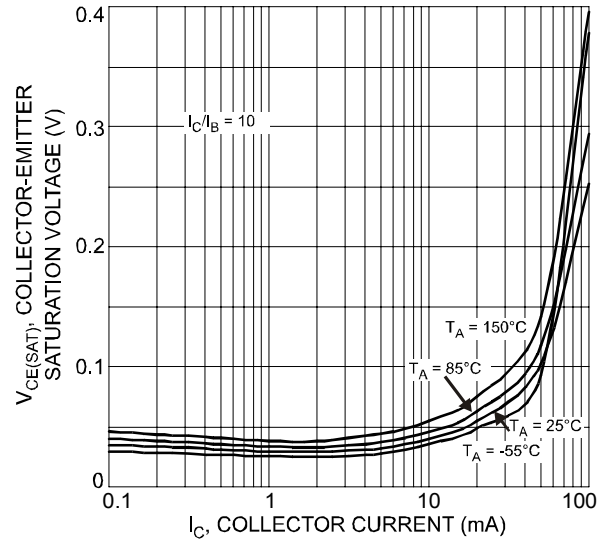

Fig. 2 Typical Collector-Emitter Saturation Voltage vs. Collector Current

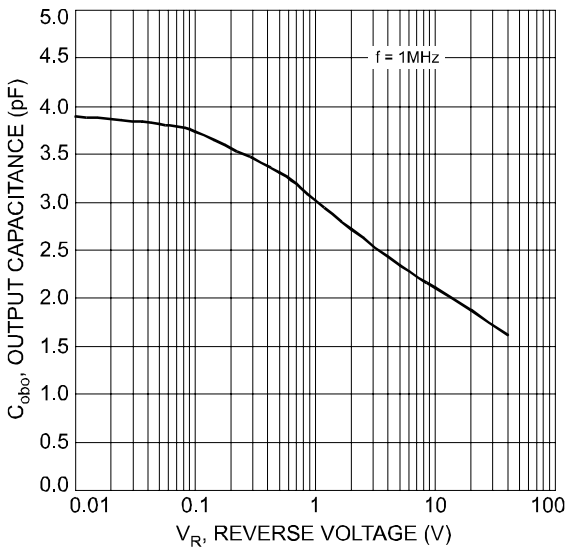

Fig. 3 Typical Output Capacitance Characteristics

Ordering Information (Note 5)

Device	Packaging	Shipping
UMG4N-7	SOT-353	3000/Tape & Reel

Notes: 5. For packaging details, go to our website at <http://www.diodes.com/datasheets/ap02007.pdf>.

Marking Information

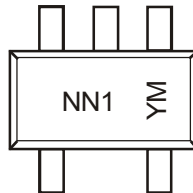

NN1 = Product Type Marking Code
 YM = Date Code Marking
 Y = Year ex: U = 2007
 M = Month ex: 9 = September

Date Code Key

Year	2007	2008	2009	2010	2011	2012
Code	U	V	W	X	Y	Z

Month	Jan	Feb	Mar	Apr	May	Jun	Jul	Aug	Sep	Oct	Nov	Dec
Code	1	2	3	4	5	6	7	8	9	O	N	D

Package Outline Dimensions

NEW PRODUCT

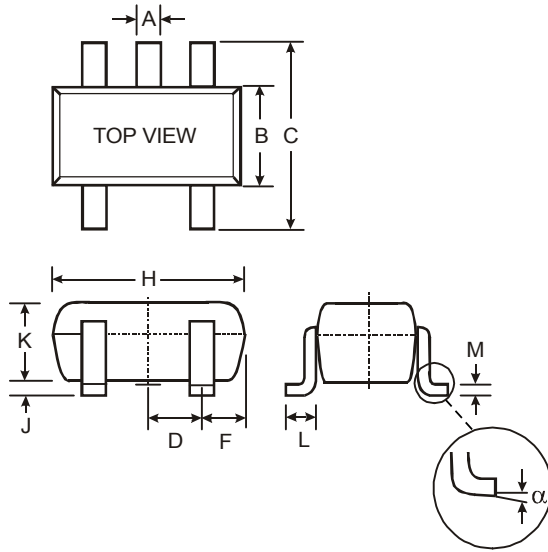

SOT-353		
Dim	Min	Max
A	0.10	0.30
B	1.15	1.35
C	2.00	2.20
D	0.65 Nominal	
F	0.30	0.40
H	1.80	2.20
J	—	0.10
K	0.90	1.00
L	0.25	0.40
M	0.10	0.25
α	0°	8°
All Dimensions in mm		

IMPORTANT NOTICE

Diodes Incorporated and its subsidiaries reserve the right to make modifications, enhancements, improvements, corrections or other changes without further notice to any product herein. Diodes Incorporated does not assume any liability arising out of the application or use of any product described herein; neither does it convey any license under its patent rights, nor the rights of others. The user of products in such applications shall assume all risks of such use and will agree to hold Diodes Incorporated and all the companies whose products are represented on our website, harmless against all damages.

LIFE SUPPORT

Diodes Incorporated products are not authorized for use as critical components in life support devices or systems without the expressed written approval of the President of Diodes Incorporated.