

# RF Power Field Effect Transistors

## N-Channel Enhancement-Mode Lateral MOSFETs

Designed for CDMA base station applications with frequencies from 1930 to 1990 MHz. Suitable for CDMA and multicarrier amplifier applications. To be used in Class AB and Class C for PCN-PCS/cellular radio and WLL applications.

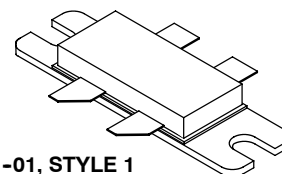
- Typical Single-Carrier W-CDMA Performance:  $V_{DD} = 28$  Volts,  $I_{DQ} = 1250$  mA,  $P_{out} = 40$  Watts Avg.,  $f = 1987.5$  MHz, IQ Magnitude Clipping, Channel Bandwidth = 3.84 MHz, Input Signal PAR = 7.5 dB @ 0.01% Probability on CCDF.
  - Power Gain — 20 dB
  - Drain Efficiency — 30%
  - Device Output Signal PAR — 6 dB @ 0.01% Probability on CCDF
  - ACPR @ 5 MHz Offset — -36 dBc in 3.84 MHz Channel Bandwidth
- Capable of Handling 10:1 VSWR, @ 32 Vdc, 1960 MHz, 130 Watts CW Output Power
- $P_{out}$  @ 1 dB Compression Point  $\approx$  130 Watts CW

### Features

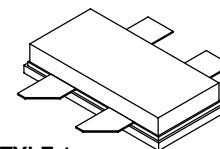
- 100% PAR Tested for Guaranteed Output Power Capability
- Characterized with Series Equivalent Large-Signal Impedance Parameters
- Internally Matched for Ease of Use
- Integrated ESD Protection
- Greater Negative Gate-Source Voltage Range for Improved Class C Operation
- RoHS Compliant
- In Tape and Reel. R3 Suffix = 250 Units per 56 mm, 13 inch Reel.

**MD7P19130HR3**  
**MD7P19130HSR3**

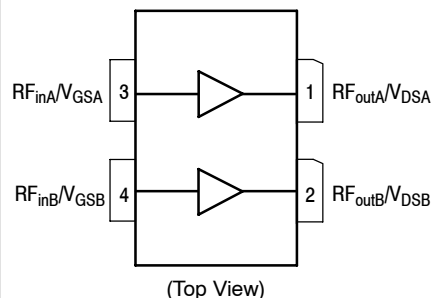
**1930-1990 MHz, 40 W AVG., 28 V**  
**SINGLE W-CDMA**  
**LATERAL N-CHANNEL**  
**RF POWER MOSFETs**



**CASE 465M-01, STYLE 1**  
**NI-780-4**  
**MD7P19130HR3**



**CASE 465H-02, STYLE 1**  
**NI-780S-4**  
**MD7P19130HSR3**



**Figure 1. Pin Connections**

**Table 1. Maximum Ratings**

Rating	Symbol	Value	Unit
Drain-Source Voltage	$V_{DSS}$	-0.5, +65	Vdc
Gate-Source Voltage	$V_{GS}$	-6.0, +10	Vdc
Operating Voltage	$V_{DD}$	32, +0	Vdc
Storage Temperature Range	$T_{stg}$	- 65 to +150	°C
Case Operating Temperature	$T_C$	150	°C
Operating Junction Temperature (1,2)	$T_J$	225	°C

1. Continuous use at maximum temperature will affect MTTF.
2. MTTF calculator available at <http://www.freescale.com/rf>. Select Software & Tools/Development Tools/Calculators to access MTTF calculators by product.

**Table 2. Thermal Characteristics**

Characteristic	Symbol	Value (1,2)	Unit
Thermal Resistance, Junction to Case Case Temperature 80°C, 130 W CW Case Temperature 75°C, 40 W CW	$R_{\theta JC}$	0.31 0.36	°C/W

**Table 3. ESD Protection Characteristics**

Test Methodology	Class
Human Body Model (per JESD22-A114)	1C (Minimum)
Machine Model (per EIA/JESD22-A115)	A (Minimum)
Charge Device Model (per JESD22-C101)	IV (Minimum)

**Table 4. Electrical Characteristics** ( $T_A = 25^\circ\text{C}$  unless otherwise noted)

Characteristic	Symbol	Min	Typ	Max	Unit
----------------	--------	-----	-----	-----	------

**Off Characteristics** <sup>(3)</sup>

Zero Gate Voltage Drain Leakage Current ( $V_{DS} = 65\text{ Vdc}$ , $V_{GS} = 0\text{ Vdc}$ )	$I_{DSS}$	—	—	10	$\mu\text{Adc}$
Zero Gate Voltage Drain Leakage Current ( $V_{DS} = 28\text{ Vdc}$ , $V_{GS} = 0\text{ Vdc}$ )	$I_{DSS}$	—	—	1	$\mu\text{Adc}$
Gate-Source Leakage Current ( $V_{GS} = 5\text{ Vdc}$ , $V_{DS} = 0\text{ Vdc}$ )	$I_{GSS}$	—	—	1	$\mu\text{Adc}$

**On Characteristics** <sup>(3)</sup>

Gate Threshold Voltage ( $V_{DS} = 10\text{ Vdc}$ , $I_D = 316\ \mu\text{Adc}$ )	$V_{GS(th)}$	1.2	2	2.7	Vdc
Gate Quiescent Voltage ( $V_{DD} = 28\text{ Vdc}$ , $I_D = 1250\text{ mAdc}$ , Measured in Functional Test)	$V_{GS(Q)}$	1.9	2.7	3.4	Vdc
Drain-Source On-Voltage ( $V_{GS} = 10\text{ Vdc}$ , $I_D = 3.16\text{ Adc}$ )	$V_{DS(on)}$	0.1	0.2	0.3	Vdc

**Dynamic Characteristics** <sup>(3,4)</sup>

Reverse Transfer Capacitance ( $V_{DS} = 28\text{ Vdc} \pm 30\text{ mV(rms)ac}$ @ 1 MHz, $V_{GS} = 0\text{ Vdc}$ )	$C_{rss}$	—	1.2	—	pF
Output Capacitance ( $V_{DS} = 28\text{ Vdc} \pm 30\text{ mV(rms)ac}$ @ 1 MHz, $V_{GS} = 0\text{ Vdc}$ )	$C_{oss}$	—	586	—	pF
Input Capacitance ( $V_{DS} = 28\text{ Vdc}$ , $V_{GS} = 0\text{ Vdc} \pm 30\text{ mV(rms)ac}$ @ 1 MHz)	$C_{iss}$	—	348	—	pF

**Functional Tests** <sup>(3)</sup> (In Freescale Test Fixture, 50 ohm system)  $V_{DD} = 28\text{ Vdc}$ ,  $I_{DQ} = 1250\text{ mA}$ ,  $P_{out} = 40\text{ W Avg.}$ ,  $f = 1987.5\text{ MHz}$ , Single-Carrier W-CDMA, IQ Magnitude Clipping, Input Signal PAR = 7.5 dB @ 0.01% Probability on CCDF. ACPR measured in 3.84 MHz Channel Bandwidth @  $\pm 5\text{ MHz}$  Offset.

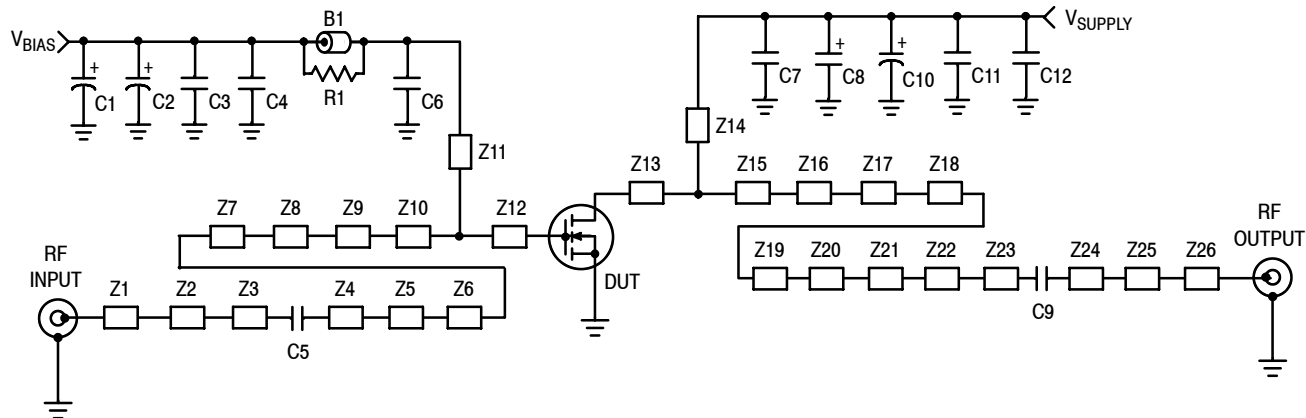
Power Gain	$G_{ps}$	18.5	20	21.5	dB
Drain Efficiency	$\eta_D$	27	30	—	%
Output Peak-to-Average Ratio @ 0.01% Probability on CCDF	PAR	5.6	6	—	dB
Adjacent Channel Power Ratio	ACPR	—	-36	-32.5	dBc
Input Return Loss	IRL	—	-16	-7	dB

1. MTTF calculator available at <http://www.freescale.com/rf>. Select Software & Tools/Development Tools/Calculators to access MTTF calculators by product.
2. Refer to AN1955, *Thermal Measurement Methodology of RF Power Amplifiers*. Go to <http://www.freescale.com/rf>. Select Documentation/Application Notes - AN1955.
3. Measurement made with device in single-ended configuration.
4. Part internally matched both on input and output.

(continued)

**Table 4. Electrical Characteristics** ( $T_A = 25^\circ\text{C}$  unless otherwise noted) (continued)

Characteristic	Symbol	Min	Typ	Max	Unit
<b>Typical Performances</b> (In Freescale Test Fixture, 50 ohm system) $V_{DD} = 28\text{ Vdc}$ , $I_{DQ} = 1250\text{ mA}$ , 1930-1990 MHz Bandwidth					
$P_{out}$ @ 1 dB Compression Point, CW	P1dB	—	130	—	W
Gain Flatness in 60 MHz Bandwidth @ $P_{out} = 40\text{ W Avg.}$	$G_F$	—	0.3	—	dB
Average Deviation from Linear Phase in 60 MHz Bandwidth @ $P_{out} = 130\text{ W CW}$	$\Phi$	—	0.5	—	$^\circ$
Average Group Delay @ $P_{out} = 130\text{ W CW}$ , $f = 1960\text{ MHz}$	Delay	—	2.3	—	ns
Part-to-Part Insertion Phase Variation @ $P_{out} = 130\text{ W CW}$ , $f = 1960\text{ MHz}$ , Six Sigma Window	$\Delta\Phi$	—	80	—	$^\circ$
Gain Variation over Temperature (-30°C to +85°C)	$\Delta G$	—	0.016	—	dB/ $^\circ\text{C}$
Output Power Variation over Temperature (-30°C to +85°C)	$\Delta P1dB$	—	0.01	—	dB/ $^\circ\text{C}$



Z1	0.582" x 0.110" Microstrip	Z15	0.203" x 0.957" Microstrip
Z2	0.140" x 0.284" Microstrip	Z16	0.271" x 0.930" Microstrip
Z3	0.066" x 0.080" Microstrip	Z17	0.010" x 0.540" Microstrip
Z4	0.127" x 0.080" Microstrip	Z18	0.042" x 0.205" Microstrip
Z5	0.042" x 0.237" Microstrip	Z19	0.471" x 0.080" Microstrip
Z6	0.095" x 0.375" Microstrip	Z20	0.024" x 0.241" Microstrip
Z7	0.330" x 0.320" Microstrip	Z21	0.057" x 0.349" Microstrip
Z8	0.438" x 0.530" Microstrip	Z22	0.781" x 0.311" Microstrip
Z9	0.311" x 0.741" Microstrip	Z23	0.271" x 0.080" Microstrip
Z10	0.025" x 0.814" Microstrip	Z24	0.024" x 0.095" Microstrip
Z11	0.049" x 0.254" Microstrip	Z25	0.134" x 0.190" Microstrip
Z12	0.078" x 0.814" Microstrip	Z26	0.511" x 0.080" Microstrip
Z13	0.134" x 0.957" Microstrip	PCB	Arlon CuClad 250GX-0300-55-22, 0.030", $\epsilon_r = 2.55$
Z14	0.150" x 0.276" Microstrip		

**Figure 2. MD7P19130HR3(HSR3) Test Circuit Schematic**

**Table 5. MD7P19130HR3(HSR3) Test Circuit Component Designations and Values**

Part	Description	Part Number	Manufacturer
B1	Short Ferrite Bead	2743019447 ROP50	Fair-Rite
C1	47 $\mu$ F, 50 V Electrolytic Capacitor	476KXM063M	Illinois Cap.
C2	100 $\mu$ F, 50 V Electrolytic Capacitor	T491C105K050AT	Kemet
C3	1.0 $\mu$ F Chip Capacitor	ATC100B102JT50XT	ATC
C4, C12	0.1 $\mu$ F Chip Capacitors	CDR33BX104AKYS	Kemet
C5, C9	11 pF Chip Capacitors	ATC100B110JT500XT	ATC
C6	13 pF Chip Capacitor	ATC100B130JT500XT	ATC
C7	8.2 pF Chip Capacitor	ATC100B8R2JT500XT	ATC
C8	22 $\mu$ F, 35 V Tantalum Capacitor	T491C226K035AT	Kemet
C10	470 $\mu$ F, 63 V Electrolytic Capacitor	477KXM063M	Illinois Cap.
C11	10 $\mu$ F, 50 V Chip Capacitor	GRM55DR61H106KA88B	Murata
R1	10 $\Omega$ , 1/4 W Chip Resistor	CRCW120610R0FKEA	Vishay

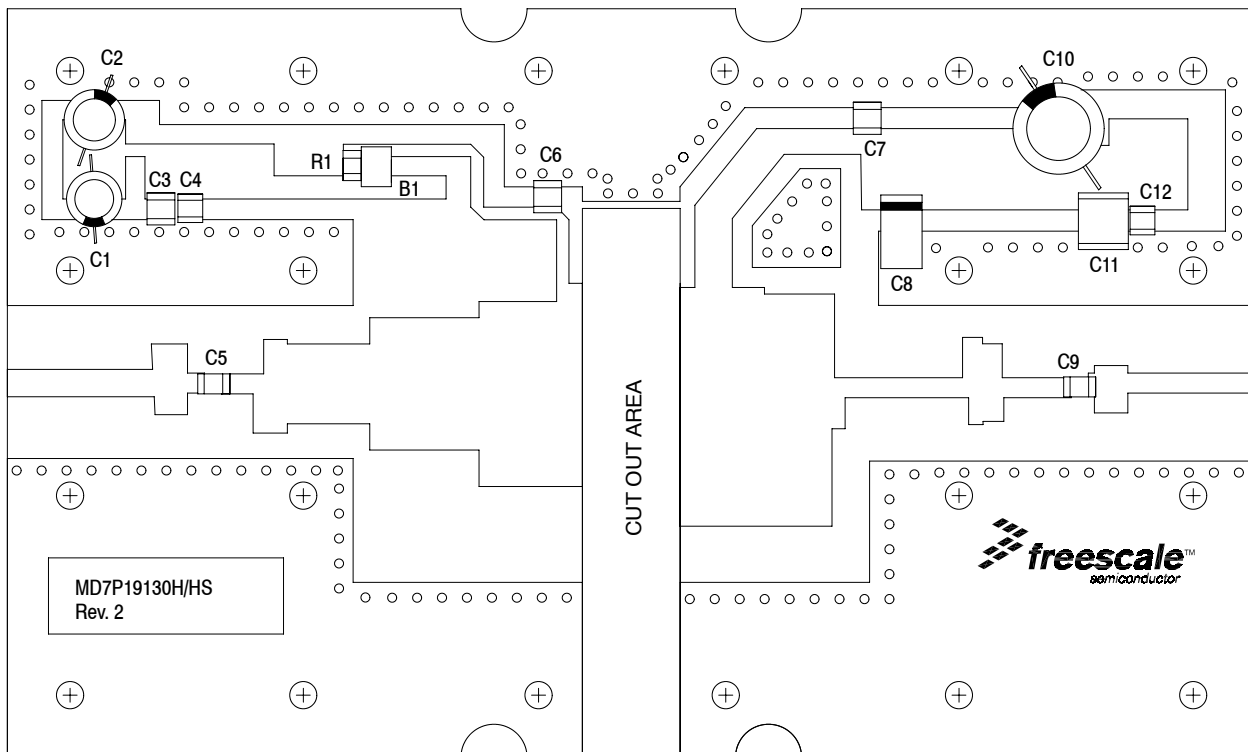


Figure 3. MD7P19130HR3(HSR3) Test Circuit Component Layout

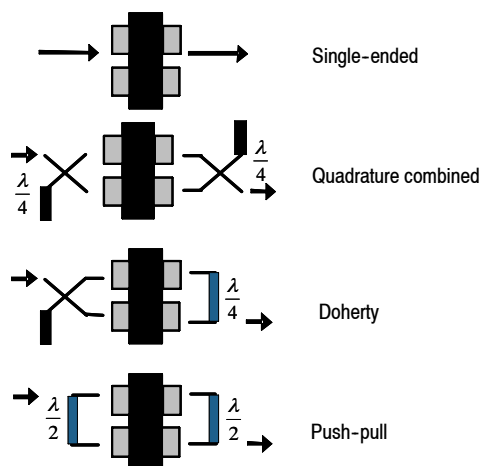
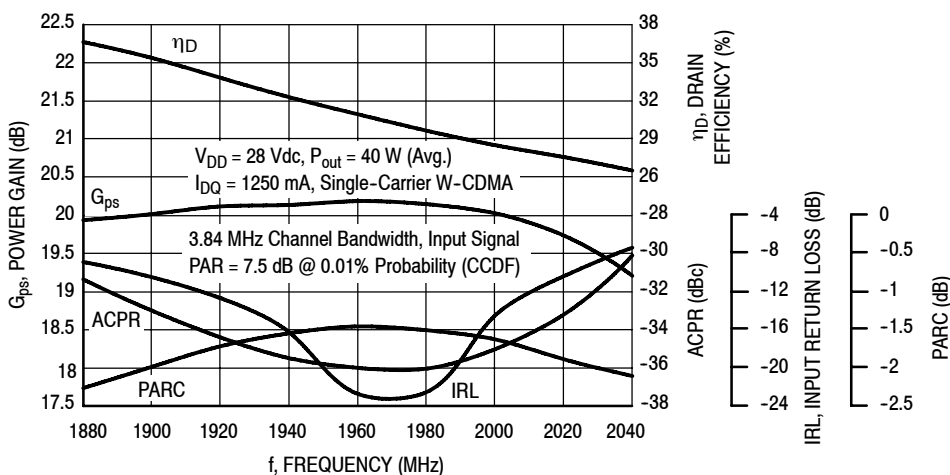
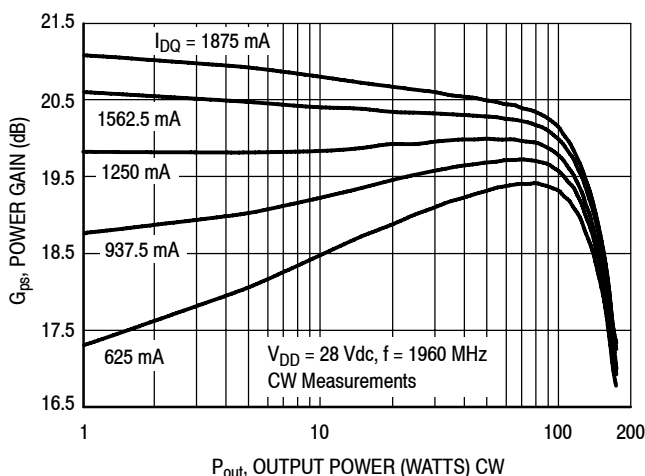


Figure 4. Possible Circuit Topologies

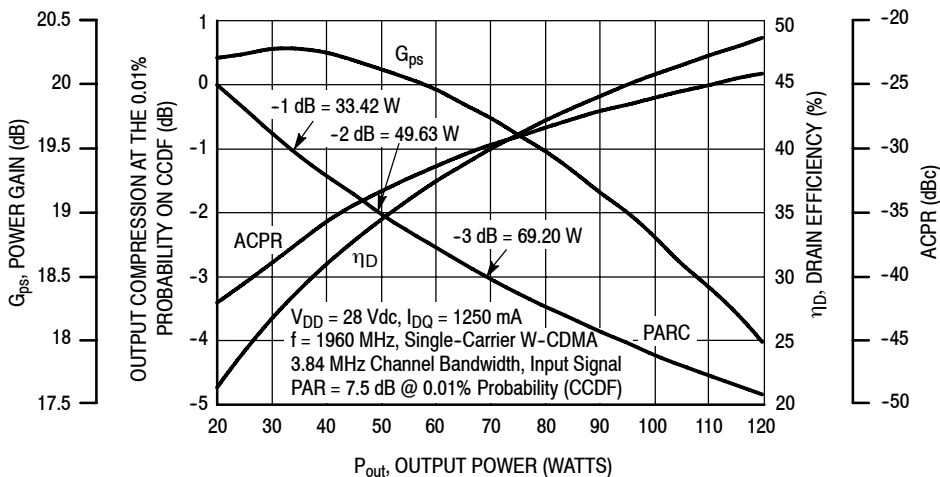
### TYPICAL CHARACTERISTICS



**Figure 5. Output Peak-to-Average Ratio Compression (PARC) Broadband Performance @  $P_{out} = 40$  Watts Avg.**

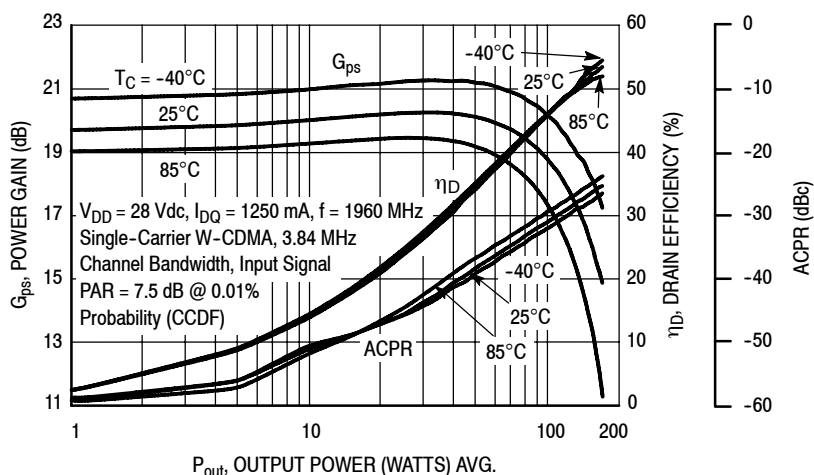


**Figure 6. CW Power Gain versus Output Power**

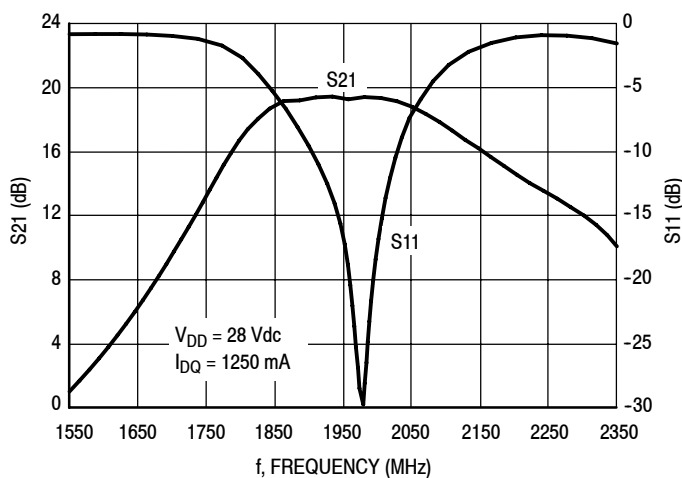


**Figure 7. Output Peak-to-Average Ratio Compression (PARC) versus Output Power**

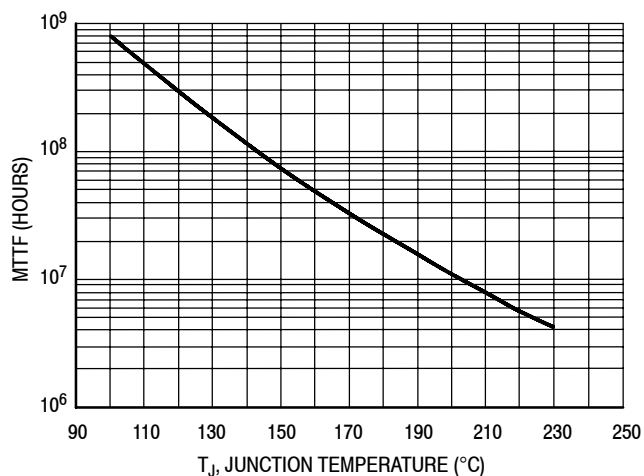
### TYPICAL CHARACTERISTICS



**Figure 8. Single-Carrier W-CDMA Power Gain, Drain Efficiency and ACPR versus Output Power**



**Figure 9. Broadband Frequency Response**

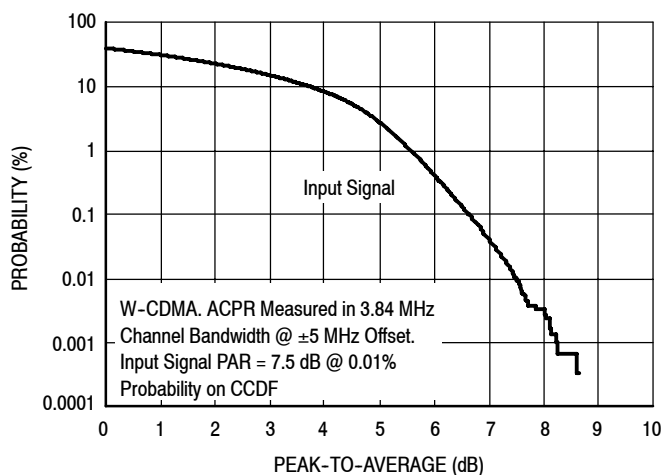


This above graph displays calculated MTTF in hours when the device is operated at  $V_{DD} = 28$  Vdc,  $P_{out} = 40$  W Avg., and  $\eta_D = 30\%$ .

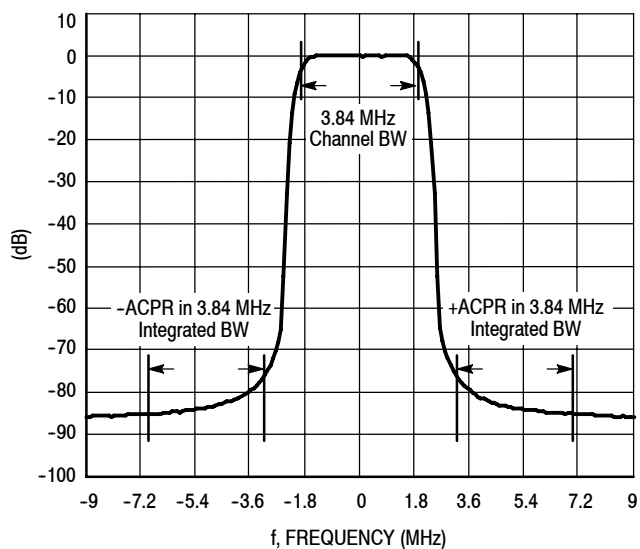
MTTF calculator available at <http://www.freescale.com/rf>. Select Software & Tools/Development Tools/Calculators to access MTTF calculators by product.

**Figure 10. MTTF versus Junction Temperature**

### W-CDMA TEST SIGNAL

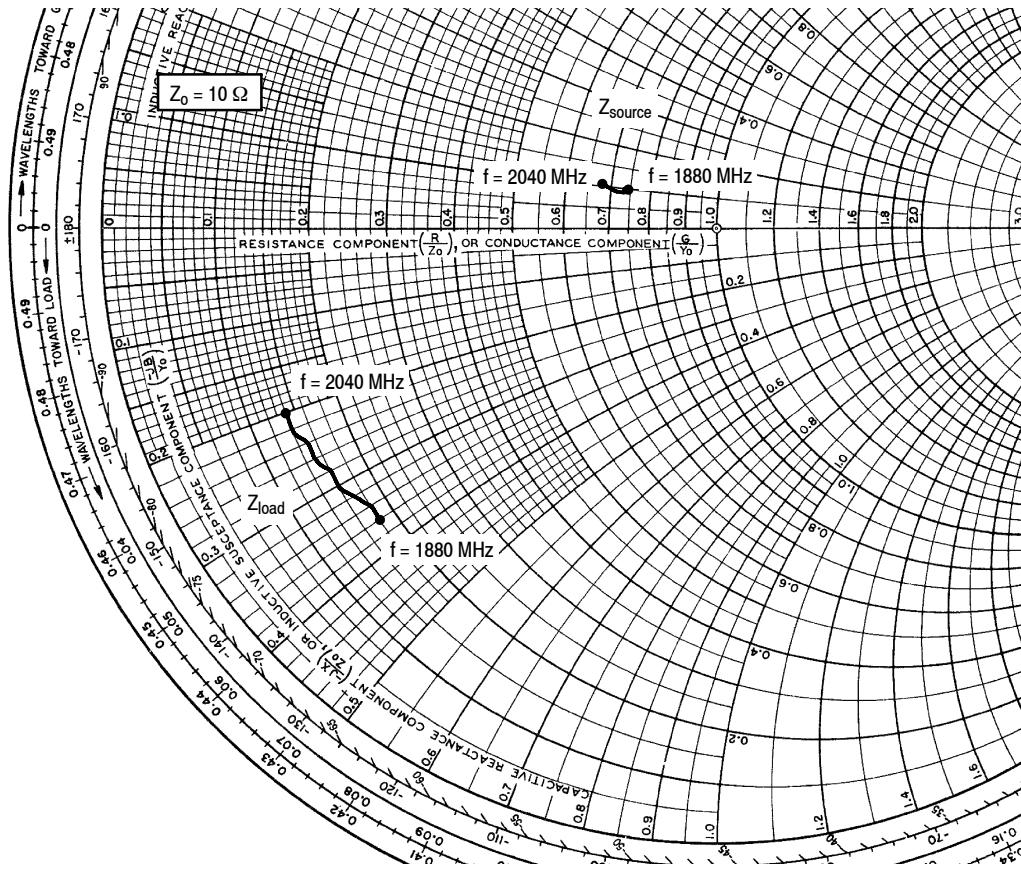


**Figure 11. CCDF W-CDMA IQ Magnitude Clipping, Single-Carrier Test Signal**



**Figure 12. Single-Carrier W-CDMA Spectrum**





$V_{DD} = 28 \text{ Vdc}$ ,  $I_{DQ} = 1250 \text{ mA}$ ,  $P_{out} = 40 \text{ W Avg.}$

f MHz	$Z_{source}$ $\Omega$	$Z_{load}$ $\Omega$
1880	$7.37 + j1.00$	$1.84 - j3.56$
1900	$7.33 + j0.96$	$1.78 - j3.37$
1920	$7.27 + j0.93$	$1.72 - j3.17$
1940	$7.19 + j0.90$	$1.64 - j2.98$
1960	$7.07 + j0.89$	$1.55 - j2.79$
1980	$6.93 + j0.97$	$1.48 - j2.55$
2000	$6.89 + j1.04$	$1.46 - j2.36$
2020	$6.83 + j1.07$	$1.44 - j2.20$
2040	$6.75 + j1.12$	$1.40 - j2.02$

$Z_{source}$  = Test circuit impedance as measured from gate to ground.

$Z_{load}$  = Test circuit impedance as measured from drain to ground.

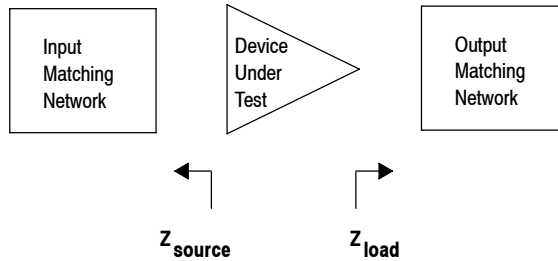
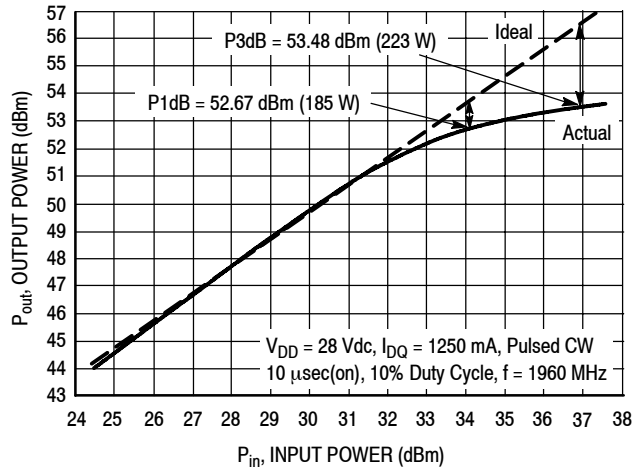


Figure 13. Series Equivalent Source and Load Impedance

## ALTERNATIVE PEAK TUNE LOAD PULL CHARACTERISTICS



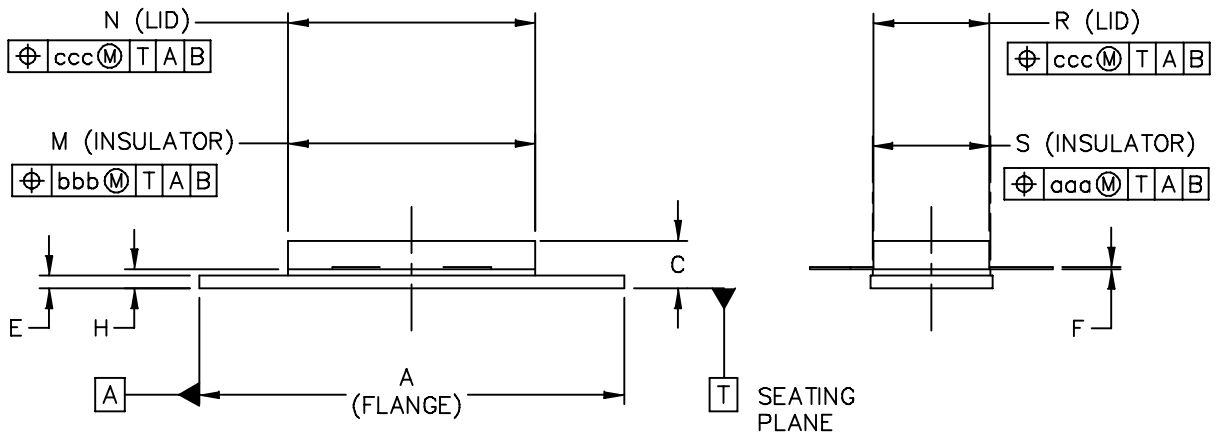
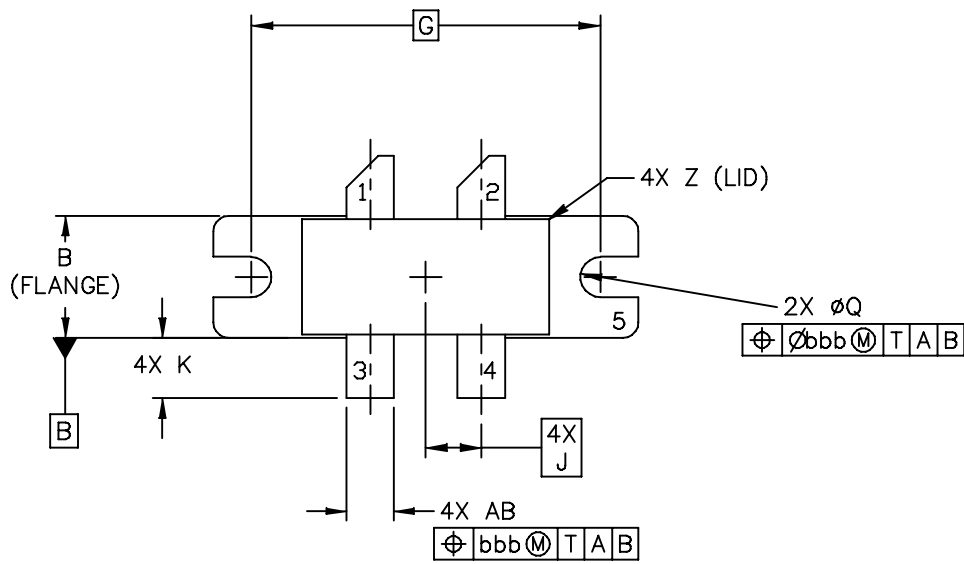
NOTE: Load Pull Test Fixture Tuned for Peak P1dB Output Power @ 28 V

Test Impedances per Compression Level

	$Z_{\text{source}}$ $\Omega$	$Z_{\text{load}}$ $\Omega$
P1dB	$7.15 - j1.86$	$0.84 - j2.99$

**Figure 14. Pulsed CW Output Power versus Input Power @ 28 V**

### PACKAGE DIMENSIONS



© FREESCALE SEMICONDUCTOR, INC. ALL RIGHTS RESERVED.	MECHANICAL OUTLINE	PRINT VERSION NOT TO SCALE	
TITLE:  NI 780-4	DOCUMENT NO: 98ASA10793D	REV: 0	
	CASE NUMBER: 465M-01	27 MAR 2007	
	STANDARD: NON-JEDEC		

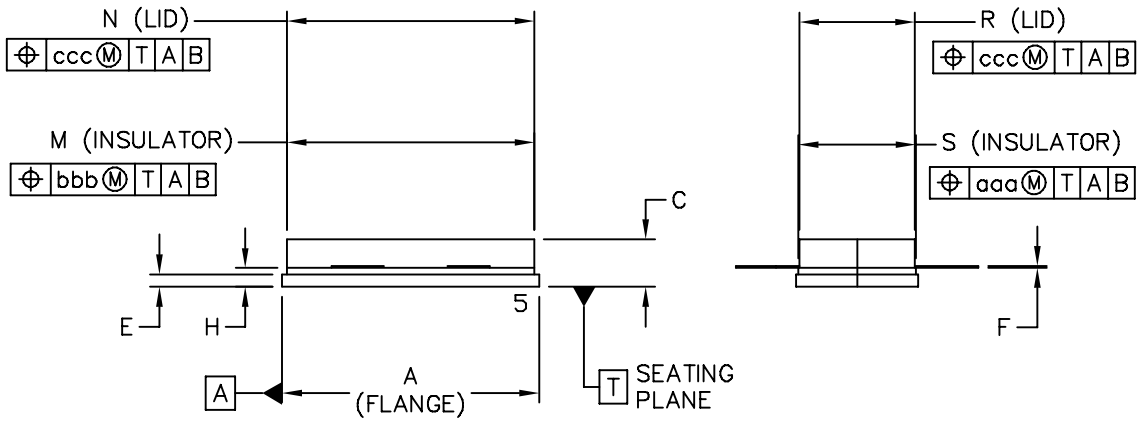
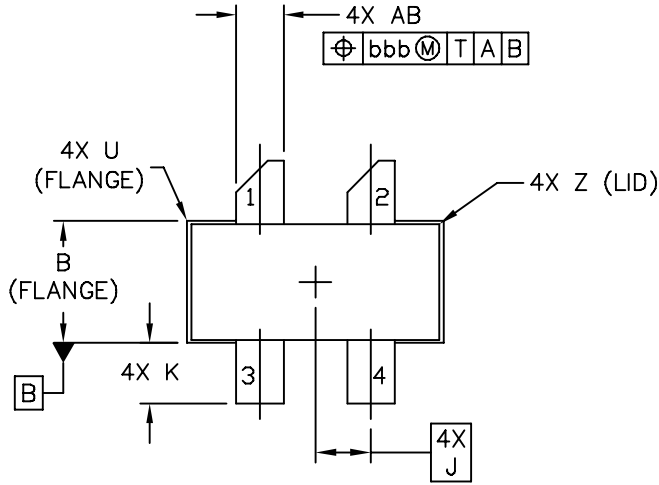
NOTES:

1. DIMENSIONING AND TOLERANCING PER ANSI Y14.5M-1994.
2. CONTROLLING DIMENSION: INCH.
3. DIMENSION H IS MEASURED .030 (0.762) AWAY FROM PACKAGE BODY.

STYLE 1:

- PIN
1. DRAIN
  2. DRAIN
  3. GATE
  4. GATE
  5. SOURCE

DIM	INCH		MILLIMETER		DIM	INCH		MILLIMETER	
	MIN	MAX	MIN	MAX		MIN	MAX	MIN	MAX
A	1.335	1.345	33.91	34.16	R	.365	.375	9.27	9.53
B	.380	.390	9.65	9.91	S	.365	.375	9.27	9.52
C	.125	.170	3.18	4.32	U		.040		1.02
E	.035	.045	0.89	1.14	Z		.030		0.76
F	.003	.006	0.08	0.15	AB	.145	.155	3.68	3.94
G	1.100 BSC		27.94 BSC						
H	.057	.067	1.45	1.7	aaa		.005		0.127
J	.175 BSC		4.44 BSC		bbb		.010		0.254
K	.170	.210	4.32	5.33	ccc		.015		0.381
M	.774	.786	19.61	20.02					
N	.772	.788	19.61	20.02					
Q	Ø.118	Ø.138	Ø3	Ø3.51					
© FREESCALE SEMICONDUCTOR, INC. ALL RIGHTS RESERVED.			MECHANICAL OUTLINE			PRINT VERSION NOT TO SCALE			
TITLE:  NI 780-4					DOCUMENT NO: 98ASA10793D			REV: 0	
					CASE NUMBER: 465M-01			27 MAR 2007	
					STANDARD: NON-JEDEC				



© FREESCALE SEMICONDUCTOR, INC. ALL RIGHTS RESERVED.	<b>MECHANICAL OUTLINE</b>	PRINT VERSION NOT TO SCALE	
TITLE:  NI 780S-4	DOCUMENT NO: 98ASA10718D	REV: A	
	CASE NUMBER: 465H-02	27 MAR 2007	
	STANDARD: NON-JEDEC		

NOTES:

1. DIMENSIONING AND TOLERANCING PER ANSI Y14.5M-1994.
2. CONTROLLING DIMENSION: INCH.
3. DELETED
4. DIMENSION H IS MEASURED .030 (0.762) AWAY FROM PACKAGE BODY.

STYLE 1:

- PIN 1. DRAIN  
 2. DRAIN  
 3. GATE  
 4. GATE  
 5. SOURCE

DIM	INCH		MILLIMETER		DIM	INCH		MILLIMETER	
	MIN	MAX	MIN	MAX		MIN	MAX	MIN	MAX
A	.805	.815	20.45	20.7	U		.040		1.02
B	.380	.390	9.65	9.91	Z		.030		0.76
C	.125	.170	3.18	4.32	AB	.145	.155	3.68	- 3.94
E	.035	.045	0.89	1.14					
F	.003	.006	0.08	0.15	aaa		.005		0.127
H	.057	.067	1.45	1.7	bbb		.010		0.254
J	.175 BSC		4.44 BSC		ccc		.015		0.381
K	.170	.210	4.32	5.33					
M	.774	.786	19.61	20.02					
N	.772	.788	19.61	20.02					
R	.365	.375	9.27	9.53					
S	.365	.375	9.27	9.52					
© FREESCALE SEMICONDUCTOR, INC. ALL RIGHTS RESERVED.			<b>MECHANICAL OUTLINE</b>			PRINT VERSION NOT TO SCALE			
TITLE:  NI 780S-4					DOCUMENT NO: 98ASA10718D			REV: A	
					CASE NUMBER: 465H-02			27 MAR 2007	
					STANDARD: NON-JEDEC				

## PRODUCT DOCUMENTATION AND SOFTWARE

Refer to the following documents to aid your design process.

### Application Notes

- AN1955: Thermal Measurement Methodology of RF Power Amplifiers

### Engineering Bulletins

- EB212: Using Data Sheet Impedances for RF LDMOS Devices

### Software

- Electromigration MTTF Calculator
- RF High Power Model

For Software, do a Part Number search at <http://www.freescale.com>, and select the “Part Number” link. Go to the Software & Tools tab on the part’s Product Summary page to download the respective tool.

## REVISION HISTORY

The following table summarizes revisions to this document.

Revision	Date	Description
0	May 2008	<ul style="list-style-type: none"> <li>• Initial Release of Data Sheet</li> </ul>
1	Dec. 2008	<ul style="list-style-type: none"> <li>• Corrected the pin order in Fig. 1, Pin Connections, to match the Mechanical Outline pin order, p. 1</li> </ul>
2	Aug. 2010	<ul style="list-style-type: none"> <li>• Modified data sheet to reflect RF Test Reduction described in Product and Process Change Notification number, PCN13628, p. 1, 2</li> <li>• Updated Fig. 14, CCDF W-CDMA IQ Magnitude Clipping, Single-Carrier Test Signal, to better represent production test signal, p. 8</li> <li>• Updated Fig. 15, Single-Carrier W-CDMA Spectrum, to better represent production test signal, p. 8</li> <li>• Added Electromigration MTTF Calculator and RF High Power Model availability to Product Software, p. 15</li> </ul>

## **How to Reach Us:**

### **Home Page:**

[www.freescale.com](http://www.freescale.com)

### **Web Support:**

<http://www.freescale.com/support>

### **USA/Europe or Locations Not Listed:**

Freescale Semiconductor, Inc.  
Technical Information Center, EL516  
2100 East Elliot Road  
Tempe, Arizona 85284  
1-800-521-6274 or +1-480-768-2130  
[www.freescale.com/support](http://www.freescale.com/support)

### **Europe, Middle East, and Africa:**

Freescale Halbleiter Deutschland GmbH  
Technical Information Center  
Schatzbogen 7  
81829 Muenchen, Germany  
+44 1296 380 456 (English)  
+46 8 52200080 (English)  
+49 89 92103 559 (German)  
+33 1 69 35 48 48 (French)  
[www.freescale.com/support](http://www.freescale.com/support)

### **Japan:**

Freescale Semiconductor Japan Ltd.  
Headquarters  
ARCO Tower 15F  
1-8-1, Shimo-Meguro, Meguro-ku,  
Tokyo 153-0064  
Japan  
0120 191014 or +81 3 5437 9125  
[support.japan@freescale.com](mailto:support.japan@freescale.com)

### **Asia/Pacific:**

Freescale Semiconductor China Ltd.  
Exchange Building 23F  
No. 118 Jianguo Road  
Chaoyang District  
Beijing 100022  
China  
+86 10 5879 8000  
[support.asia@freescale.com](mailto:support.asia@freescale.com)

### **For Literature Requests Only:**

Freescale Semiconductor Literature Distribution Center  
1-800-441-2447 or +1-303-675-2140  
Fax: +1-303-675-2150  
[LDCForFreescaleSemiconductor@hibbertgroup.com](mailto:LDCForFreescaleSemiconductor@hibbertgroup.com)

Information in this document is provided solely to enable system and software implementers to use Freescale Semiconductor products. There are no express or implied copyright licenses granted hereunder to design or fabricate any integrated circuits or integrated circuits based on the information in this document.

Freescale Semiconductor reserves the right to make changes without further notice to any products herein. Freescale Semiconductor makes no warranty, representation or guarantee regarding the suitability of its products for any particular purpose, nor does Freescale Semiconductor assume any liability arising out of the application or use of any product or circuit, and specifically disclaims any and all liability, including without limitation consequential or incidental damages. "Typical" parameters that may be provided in Freescale Semiconductor data sheets and/or specifications can and do vary in different applications and actual performance may vary over time. All operating parameters, including "Typicals", must be validated for each customer application by customer's technical experts. Freescale Semiconductor does not convey any license under its patent rights nor the rights of others. Freescale Semiconductor products are not designed, intended, or authorized for use as components in systems intended for surgical implant into the body, or other applications intended to support or sustain life, or for any other application in which the failure of the Freescale Semiconductor product could create a situation where personal injury or death may occur. Should Buyer purchase or use Freescale Semiconductor products for any such unintended or unauthorized application, Buyer shall indemnify and hold Freescale Semiconductor and its officers, employees, subsidiaries, affiliates, and distributors harmless against all claims, costs, damages, and expenses, and reasonable attorney fees arising out of, directly or indirectly, any claim of personal injury or death associated with such unintended or unauthorized use, even if such claim alleges that Freescale Semiconductor was negligent regarding the design or manufacture of the part.

Freescale™ and the Freescale logo are trademarks of Freescale Semiconductor, Inc. All other product or service names are the property of their respective owners.

© Freescale Semiconductor, Inc. 2008, 2010. All rights reserved.